

**D-SERIES DRI
DRI424024LTD**

Weidmüller Interface GmbH & Co. KG
 Klingenbergstraße 16
 D-32758 Detmold
 Germany
 Fon: +49 5231 14-0
 Fax: +49 5231 14-292083
 www.weidmueller.com



Relay from the D-SERIES DRI

- 1 or 2 CO contacts
- Robust industrial plug-in connections
- Optional: latching / spring return operable test button with coloured control voltage identification (AC coil: red / DC coil: blue)
- Optional: Mechanical switch position indication (for version with test button)
- Optional: Bright status LED (AC coil: red / DC coil: green)
- Optional: free-wheeling diode

General ordering data

Type	DRI424024LTD
Order No.	7760056340
Version	D-SERIES DRI, Relay, No. of contacts: 2 CO contact with test button AgNi, Rated control voltage: 24 V DC, Continuous current: 5 A, Flat blade connections (2.5 mm x 0.5 mm)
GTIN (EAN)	6944 169739873
Qty.	20 pc(s).

**D-SERIES DRI
DRI424024LTD**

Weidmüller Interface GmbH & Co. KG
 Klingenbergstraße 16
 D-32758 Detmold
 Germany
 Fon: +49 5231 14-0
 Fax: +49 5231 14-292083
 www.weidmueller.com

Technical data
Dimensions and weights

Width	13 mm	Width (inches)	0.512 inch
Height	31 mm	Height (inches)	1.22 inch
Depth	33.5 mm	Depth (inches)	1.319 inch
Net weight	19.5 g		

Temperatures

Humidity	35...85 % rel. humidity, no condensation	Operating temperature	-40 °C...55 °C
Storage temperature	-40 °C...85 °C		

Input

Rated control voltage	24 V DC	Rated current DC	21,8 mA
Power rating	530 mW	Pull-in/drop-out voltage, typ.	18 V / 3.6 V DC
Coil resistance	1100 Ω ± 10 %	Status indicator	Green LED
Protective circuit	Free-wheel diode		

Output

Rated switching voltage	250 V AC	Max. switching voltage, AC	250 V
Max. switching voltage, DC	250 V	Continuous current	5 A
AC switching capacity (resistive), max.	1250 VA	DC switching capacity (resistive), max.	150 W @ 24 V
Switch-on delay	≤ 15 ms	Switch-off delay	≤ 10 ms
Min. switching power	10 mA @ 12 V, 100 mA @ 5 V	Max. switching frequency at rated load	0.1 Hz

Contact data

Contact type	2 CO contact with test button (AgNi)	Mechanical service life	10 x 10 ⁶ switching cycles
--------------	--------------------------------------	-------------------------	---------------------------------------

General data

Test button	yes (lockable)	Mechanical switch position indicator	Yes
-------------	----------------	--------------------------------------	-----

Insulation coordination

Rated voltage	300 V	Surge voltage category	III
Pollution severity	2	Insulating material group	IIIa
Protection degree	IP20	Dielectric strength input – output	5 kV _{eff} / 1 min
Creepage and clearance distance input – output	≥ 4 mm	Dielectric strength of neighbouring contacts	1.5 kV _{eff} / 1 min.
Dielectric strength of open contact	1 kV _{eff} / 1 min	Impulse withstand voltage	5 kV (1.2/50 μs)

Further details of approvals / standards

Standards	IEC 61810-1, EN 60664-1:2007, EN 61000-6-2:2005, EN 61000-6-4:2007 + A1:2011, UL 508	Certificate No. (cURus)	E312083
-----------	--	-------------------------	---------

Data sheet

**D-SERIES DRI
DRI424024LTD**

Weidmüller Interface GmbH & Co. KG
 Klingenbergstraße 16
 D-32758 Detmold
 Germany
 Fon: +49 5231 14-0
 Fax: +49 5231 14-292083
 www.weidmueller.com

Technical data

Connection data

Wire connection method Flat blade connections
 (2.5 mm x 0.5 mm)

Classifications

ETIM 5.0	EC001437	ETIM 6.0	EC001437
eClass 6.2	27-37-16-01	eClass 7.1	27-37-16-01
eClass 8.1	27-37-16-01	eClass 9.0	27-37-16-01
eClass 9.1	27-37-16-01		

Approvals

Approvals



ROHS Conform

Downloads

Approval/Certificate/Document of Conformity	DE_PA_5600_160310_002.pdf
Engineering Data	EPLAN_WSCAD

**D-SERIES DRI
DRI424024LTD**

Weidmüller Interface GmbH & Co. KG
 Klingenbergstraße 16
 D-32758 Detmold
 Germany
 Fon: +49 5231 14-0
 Fax: +49 5231 14-292083
 www.weidmueller.com

Drawings

Wiring diagram

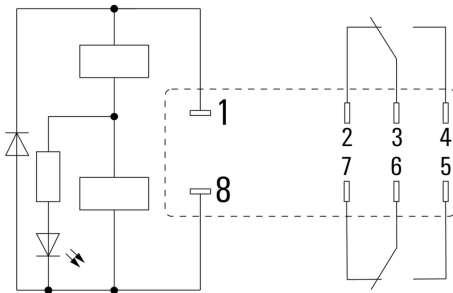

View of Pins from below

Graph



Graph



Graph



Dimensional drawing

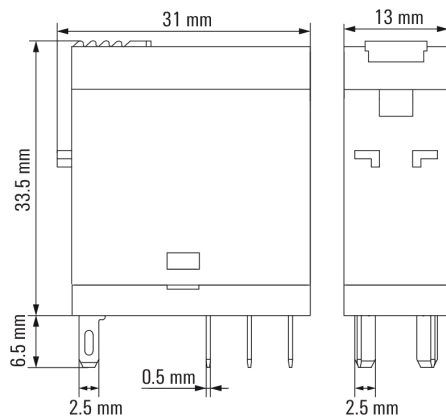

Data sheet

**D-SERIES DRI
DRI424024LTD**

Weidmüller Interface GmbH & Co. KG
 Klingenbergstraße 16
 D-32758 Detmold
 Germany
 Fon: +49 5231 14-0
 Fax: +49 5231 14-292083
 www.weidmueller.com

Drawings

Miscellaneous

Type code		DRI					
Type	DRI						
Type of construction	314 1 CO contact 424 2 CO contacts						
Coil voltage	012 12 V DC 024 24 V DC 048 48 V DC 110 110 V DC	524 24 V AC 615 115 V AC 730 230 V AC					
LED	L (Red for AC coil; green for DC coil)						
Test lever including mechanical status indicator	T (Red lever for AC coil; blue lever for DC coil)						
Free wheeling diode	D						

Type codes